

Specification sheet LX 1981

LORO-X DUOSTREAM Cascade drainage for roof terrace

Main drainage	
Gravity flow	
Silent	
Discharge rate:	max. 2,0 l/sec
Water height:	35 mm
Roof penetration:	-
Diameter:	DN 100
LX-Number:	LX 1981
Weir height:	0 mm
Drain:	ventilated
Downpipe:	ventilated
Downpipe height:	min. 2,5 m
Drainage:	in Grundleitung
Flange:	Bonding flange

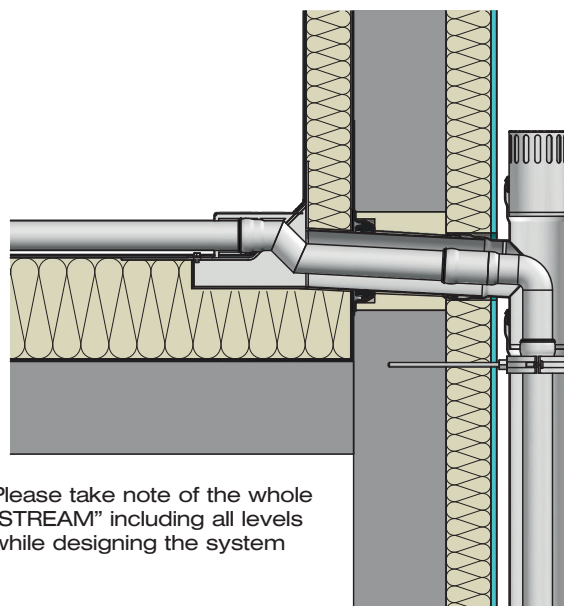

Please take note of the whole "STREAM" including all levels while designing the system

LX 1981 Piece list

- 1 x Art.-No. choose drain on page two!
- 1 x Art.-No. 01401.100X Pipe with one socket
- 1 x Art.-No. 01401.050X Pipe with one socket
- 1 x Art.-No. 13500.100X Branch with bend
- 1 x Art.-No. 13217.100X Ventilation piece

- 1 x Art.-No. 13242.DBOX, Branch with bend for redirecting the overpressure flow
- 4 x Art.-No. 00911.050X Sealing elements
- 2 x Art.-No. 00911.100X Sealing elements
- 1 x Art.-No. 00986.000X Gleitmittel

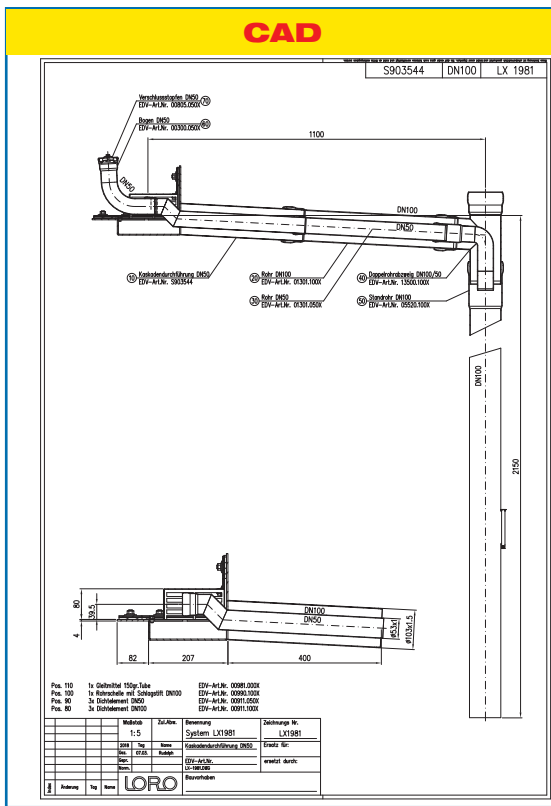
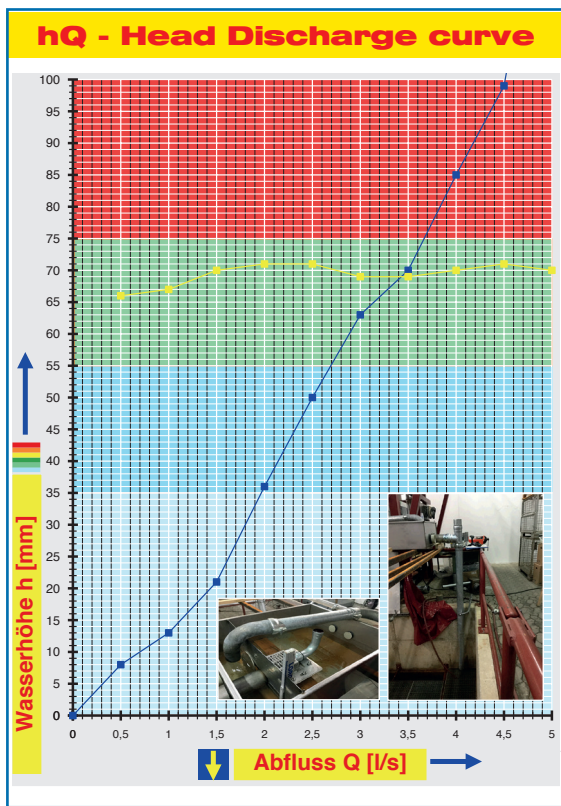

Water height	mm	10	15	20	25	30	35	40	45	50	55	60	65	70	75	80	85
Discharge	l/sec	0,7	1,1	1,4	1,6	1,8	2,0	2,1	2,3	2,5	2,7	2,9	3,1	3,5	3,7	3,8	4,0

Chosse drain for piece list on page one!

DN 100

LX1981-3X

Drain: Art.-No. 13464.100X

Main drainage

Drainage of the roof terrace
clamping flange 90°

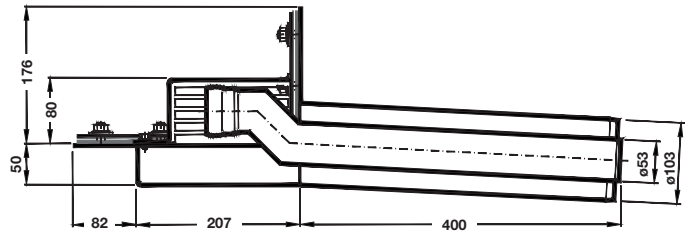
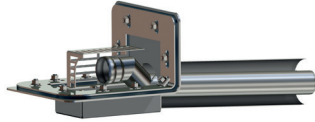

LX1981-3X

Drain: Art.-No. 13461.100X

Main drainage

Drainage of the roof terrace
bonding flange 45°

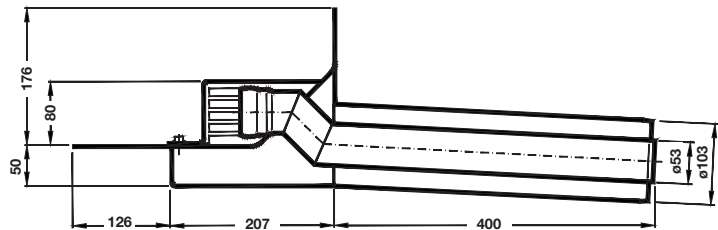

LX1981-21X

Drain: Art.-No. 13462.100X

Main drainage

Drainage of the roof terrace
bonding flange 90°

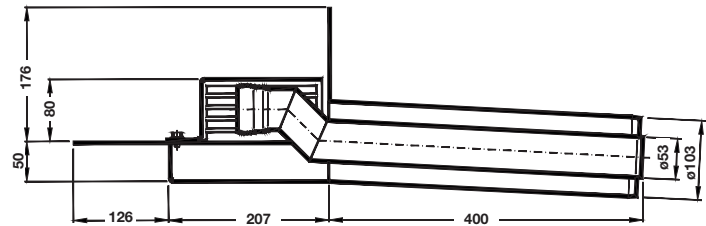
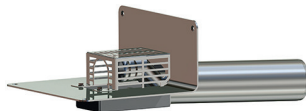

LORO-Branch with bend - Pipe in Pipe-

for redirecting the overpressure flow in the following
downpipe, made of galvanized steel

Art.-No. 13500.100X
Weight: 3,1 kg



LORO-X Ventilation piece

for downpipe ventilation,
made of galvanized steel,
DN 100

Art.-No. 13217.100X
Weight: 0,7 kg



LORO-Roof terrace deflection

from downpipe (DN 100)
into offset over roof terrace (DN 50)

Art.-No. 13242.DB0X
Weight: 1,6 kg



LORO-X Pipe with one socket,

made of galvanized steel
length 250 mm

Art.-No. 01401.050X
Art.-No. 01401.100X



LORO-Sealing elements

Art.-No. 00911.050X
Art.-No. 00911.100X